



Goforth Williamson, inc.

Goforth Williamson, Inc.  
 Mail To: 373 O'Dell Road  
 Ship To: 377 O'Dell Road  
 Griffin, GA 30224  
 United States of America

Ph: 770-467-0303

Fax: 770-467-0301

**Quote**

Number: P209421 Date: 22-May-18

To

Blue Ridge, City of  
 480 West First Street  
 Blue Ridge, GA 30513  
 United States of America

Quote To

Mark Patterson  
 Blue Ridge, City of  
 Lift Station  
 242 Windy Ridge Rd  
 Blue Ridge, GA 30513  
 United States of America

Ph: 706-632-2091

Fax: 706-632-328

Ph: 706-632-2303

Terms		Ship Via		Salesperson
Net 30 Days		Pre-Pay& ADD		JGBOS
Quantity	Description	Unit Price	Amount	
	Reference: Well Pump PER YOUR REQUEST, WE ARE PLEASED TO QUOTE THE FOLLOWING:			
1	Line: 001 Expiration Date: 21-Jun-18 Part: 19253003 Rev: 475S300-3 Grundfos Submersible Well Pump 6" NPT Discharge / 6" Motor Diameter 3 Stages All Stainless Construction 30 hp 3450 rpm 208/230 v 3 ph Motor w/ Built in Temperature Transmitter	\$6,323.00	\$6,323.00	
1	Line: 002 Expiration Date: 21-Jun-18 Part: SHIPPING & HANDLING CHARGES Rev: Freight on Inbound Materials	\$178.00	\$178.00	
	PLEASE NOTE: 1. Freight: FOB Origin, ground freight prepaid and charged to curbside of first location. 2. Price "does not" reflect Sales Tax, Documentation, Drawings, or Special Paperwork. 3. We can now accept Visa, Mastercard, American Express and Discover. Please contact us if you would like to pay via credit card. A 5% surcharge will be added to the invoice amount.  THANK YOU FOR THE OPPORTUNITY TO PROVIDE THIS QUOTE. PLEASE CALL 770-467-0303, OR YOUR SALES REP, IF YOU HAVE ANY QUESTIONS.	Total:	\$6,501.00	



Company name: Goforth Williamson  
Created by: Tony Purcell  
Phone: 770-467-0303  
Email: tony@goforthwilliamson.com  
Date: 5/22/2018

### 19253003 475S300-3 60 Hz

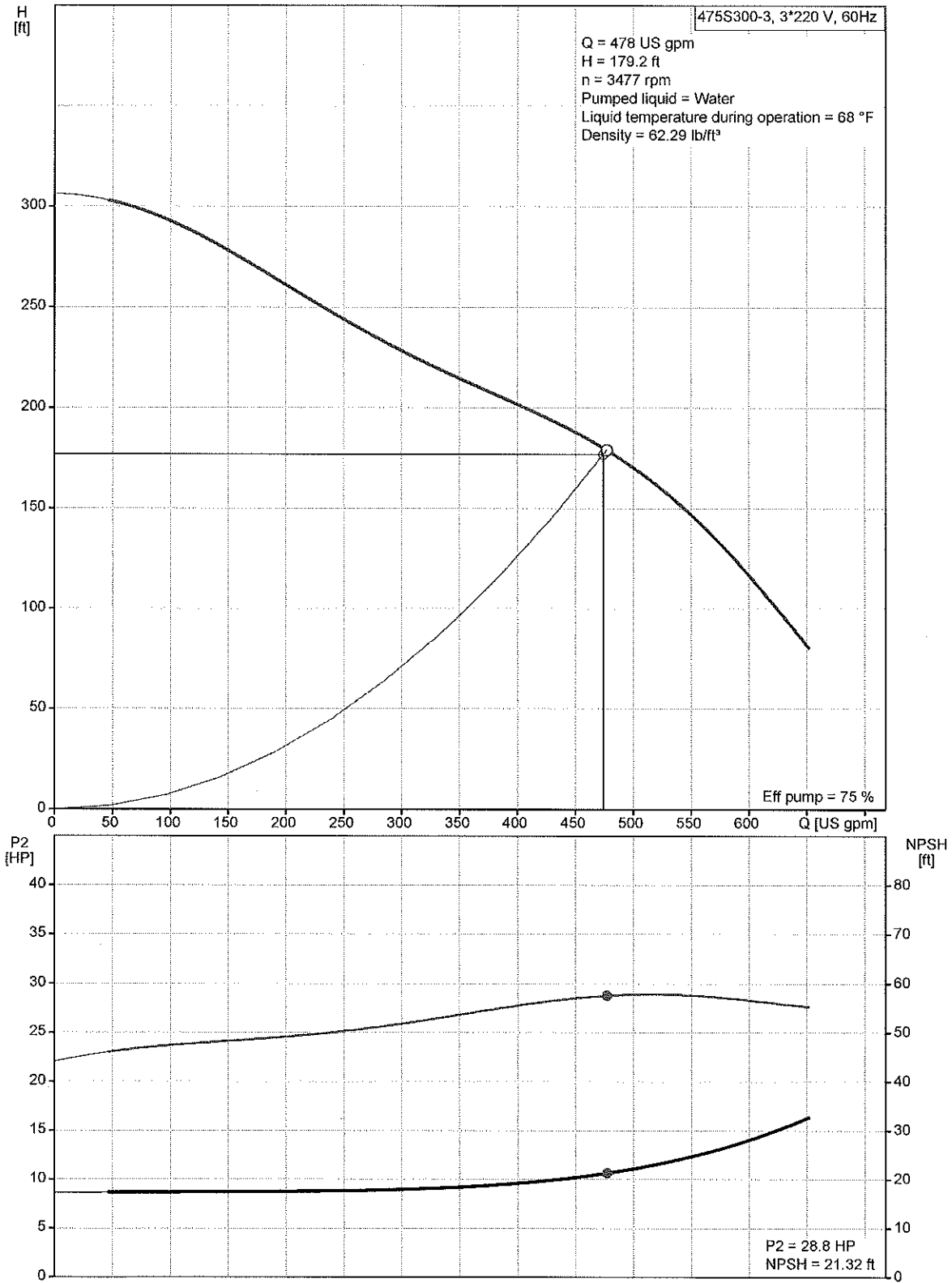



Company name: Goforth Williamson  
 Created by: Tony Purcell  
 Phone: 770-467-0303  
 Email: tony@goforthwilliamson.com  
 Date: 5/22/2018

Description	Value
<b>General information:</b>	
Product name:	475S300-3
Product No.:	19253003
EAN:	5711496474934
<b>Technical:</b>	
Speed for pump data:	3450 rpm
Actual calculated flow:	478 US gpm
Resulting head of the pump:	179.2 ft
Stages:	3
Impeller reduc.:	NONE
Shaft seal for motor:	SIC/SICNBR
Curve tolerance:	ISO9906:2012 3B
Model:	B
Valve:	YES
Motor version:	T40
<b>Materials:</b>	
Pump:	Stainless steel EN 1.4301 AISI 304
Impeller:	Stainless steel EN 1.4301 AISI 304
Motor:	Stainless steel DIN W.-Nr. 1.4301 AISI 304
<b>Installation:</b>	
Maximum ambient pressure:	870 psi
Pump outlet:	6"NPT
Motor diameter:	6 inch
<b>Liquid:</b>	
Pumped liquid:	Water
Maximum liquid temperature:	104 °F
Max liquid temperature at 0.15 m/sec:	104 °F
Liquid temperature during operation:	68 °F
Density:	62.29 lb/ft <sup>3</sup>
<b>Electrical data:</b>	
Motor type:	MS6000
Applic. motor:	GRUNDFOS
Rated power - P2:	30 HP
KVA code:	H
Main frequency:	60 Hz
Rated voltage:	3 x 208-220-230 V
Service factor:	1.15
Rated current:	104-96.5-92.0 A
Starting current:	450-520-570 %
Cos phi - power factor:	0.87-0.87-0.85
Rated speed:	3420-3450-3470 rpm
Axial load max:	59.5 lb
Start. method:	direct-on-line
Enclosure class (IEC 34-5):	IP68
Insulation class (IEC 85):	F
Motor protection:	NONE
Thermal protec:	external
Built-in temperature transmitter:	yes
Motor Number:	96166188
Cable number:	96163476
<b>Others:</b>	
ErP status:	EuP Standalone/Prod.

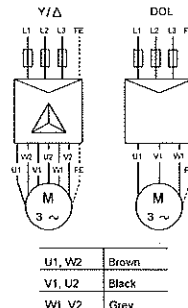
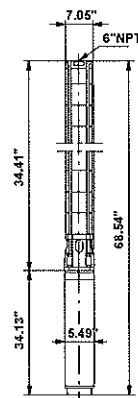
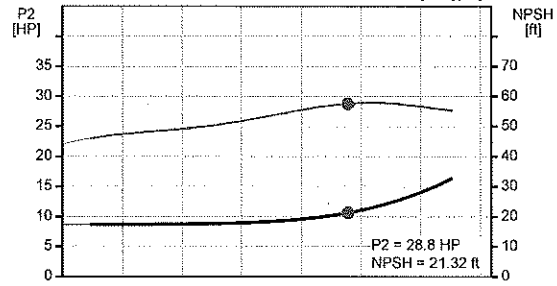
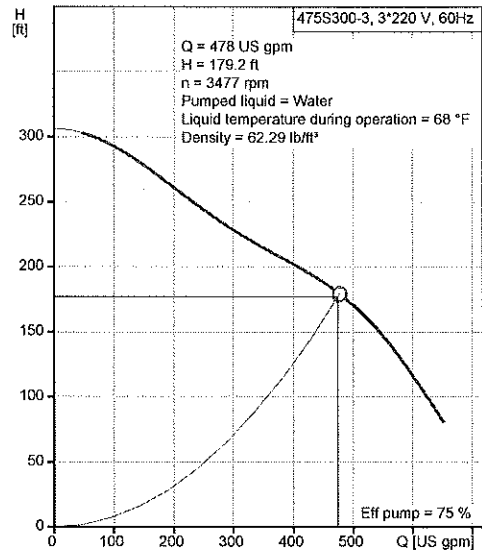



**Company name:** Goforth Williamson  
**Created by:** Tony Purcell  
**Phone:** 770-467-0303  
**Email:** tony@goforthwilliamson.com  
**Date:** 5/22/2018

Description	Value
Net weight:	227 lb
Gross weight:	292 lb
Shipping volume:	8.19 ft <sup>3</sup>
Sales region:	Namreg
Country of origin:	US
Custom tariff no.:	8413.70.2004



Company name: Goforth Williamson  
Created by: Tony Purcell  
Phone: 770-467-0303  
Email: tony@goforthwilliamson.com  
Date: 5/22/2018

### 19253003 475S300-3 60 Hz

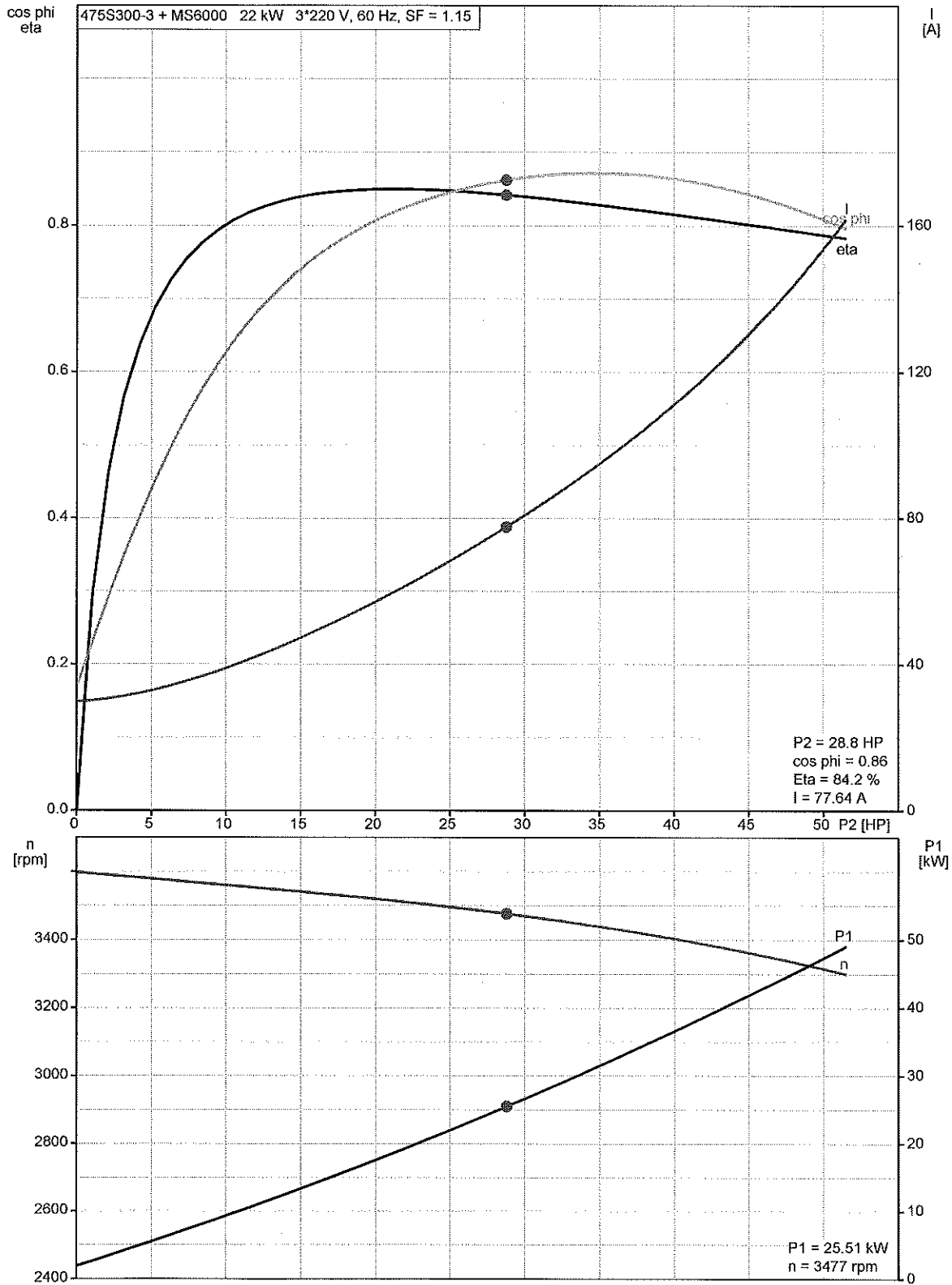

## 19253003 475S300-3 60 Hz

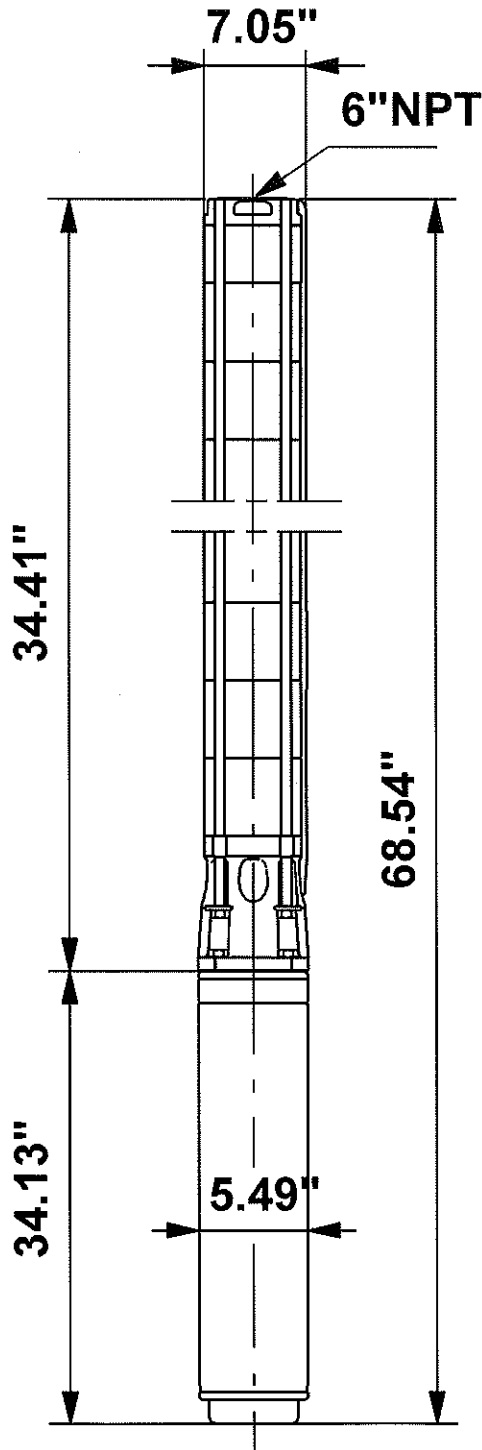

Note! All units are in [mm] unless otherwise stated.  
Disclaimer: This simplified dimensional drawing does not show all details.

## 19253003 475S300-3 60 Hz

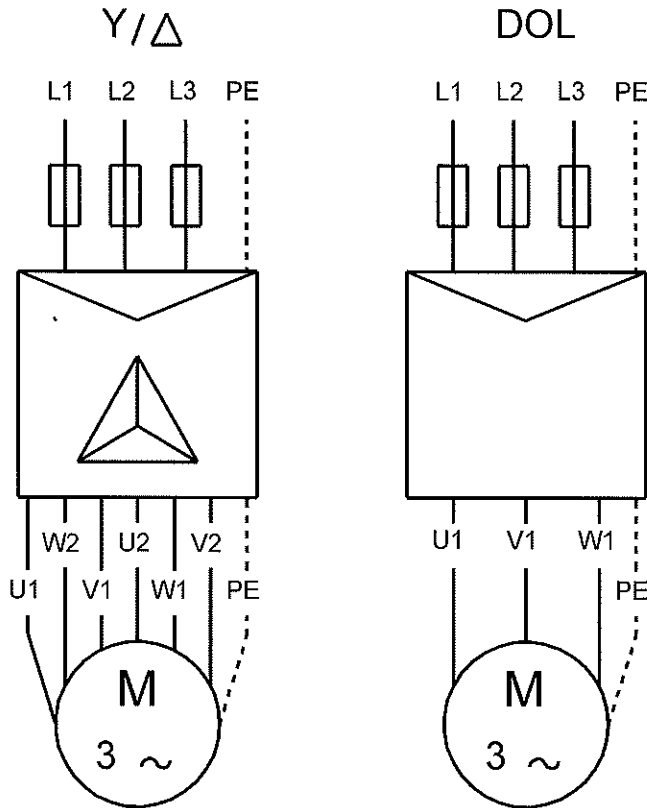

U1, W2	Brown
V1, U2	Black
W1, V2	Grey

All units are [mm] unless otherwise presented.